

LIFTING BAGS

HLB & HSB Series





HIGH PRESSURE LIFTING BAGS

Air-powered lifting bags are used for lifting, moving, spreading and fixing loads. The use of high quality materials and stringent quality control ensure safe operation. Holmatro lifting bags are capable of lifting loads up to 96 tonnes with compressed air at a pressure of 12 bar. This brochure shows both the allround HLB series and the flat shaped HSB series, that can be stacked for increased height.

The choice is yours!

TABLE OF CONTENTS

HLB LIFTING BAGS

HLB series	4
Designed around you	6
HLB lifting bags range	8
HLB system requirements	10
Advisory HLB sets	11

HSB STACK BAGS

HSB series	12
Designed around you	14
HSB Stack Bags range	16
HSB system requirements	17
Advisory HSB sets	18

THE CHOICE IS YOURS

ACCESSORIES HLB & HSB

20
22

HLB SERIES

MAXIMUM SAFETY AND CONTROL

Holmatro HLB lifting bags have been designed for safe and controlled lifting of heavy objects. With a working pressure of 12 bar you can use a smaller and lighter bag to get the job done. The unique control unit allows you to operate the lifting bags with great precision. All developed with a strong focus on ease of use.

DESIGNED AROUND YOU

It's often the small details that make a difference. An integrated carrying handle to easily pick up your lifting bag. A simple arrow for a quick visual indication of the lifting height. An extra gauge on the control unit to keep an eye on the incoming air pressure. Discover all the smart features of the HLB lifting bags range!

- Optimized non-slip design
- Aramid-reinforced, 4:1 safety
- Reflective markings



Model number imprinted

- Air inlet at a right angle
- Integrated dust cap

- Lifting capacity indication
- Chamfered edges



Control Unit HDC 12

LED-illuminated
Lightweight

AIR SOURCE PRESSURE GAUGE
Easy checking of incoming air pressure. Allows for timely air source replacement.

SAFETY COUPLER (ALSO ON HOSES)
Unlocks in two steps for improved safety: pressure release before hose disconnection.

CARRYING BAR
For easy carrying. Protects against damage and prevents accidental operation when the control is upside down.

INTUITIVE BUTTON OPERATION
Precise air flow regulation for controlled and safe lifting.

NON-RETURN VALVES
Independent controlled lifting: no risk of air pressure shifting from one bag to the other.

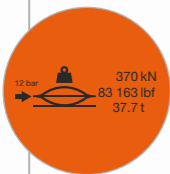

IMPORTANT INFORMATION LABELS

Clear indication of safety warnings, technical specifications and lifting height. Data matrix for equipment management in the free Holmatro Service Portal.

CENTER MARKINGS AND INTERLOCKING PROFILE

To help you position a smaller bag onto a larger model. The interlocking profile maximizes the contact area and stability of inflated lifting bags.

STANDARD SLIDER PADS

For easy insertion underneath an object.

INTEGRATED CARRYING HANDLE

Makes it easier to pull your lifting bag from the truck and take it with you.

INSERTS FOR OPTIONAL LIFTING EYES

To attach a rope for easy maneuvering of your lifting bag.

Lifting Bag HLB 38

Full system compliant with all relevant safety standards, including EN 13731.

WATCH THE VIDEO ON
HOLMATRO.COM/HLB

HLB LIFTING BAGS RANGE

Choose your lifting bag: a full range range of allround lifting bags for a wide variety of situations.



SMALL HLB 2 HLB 6 HLB 8 **MEDIUM** HLB 11 HLB 16 HLB 21 HLB 31 HLB 38

One handle. Two slider pads.

HLB lifting bags - max. working pressure 12 bar					
model	art. no.	max. lifting capacity kN/t	max. inflation height mm	dimensions (L x W x H) mm	weight kg
HLB 2	350.321.021	21 / 2.1	94	200 x 160 x 22	0.7
HLB 6	350.321.022	55 / 5.6	141	285 x 245 x 22	1.6
HLB 8	350.321.023	82 / 8.4	179	335 x 295 x 22	2.1
HLB 11	350.321.025	110 / 11.2	207	403 x 325 x 25	3.2
HLB 16	350.321.026	155 / 15.8	236	467 x 390 x 25	4.5
HLB 21	350.321.027	210 / 21.4	266	517 x 440 x 25	5.6
HLB 31	350.321.028	306 / 31.2	321	608 x 530 x 27	8.6
HLB 38	350.321.030	370 / 37.7	352	662 x 585 x 27	10

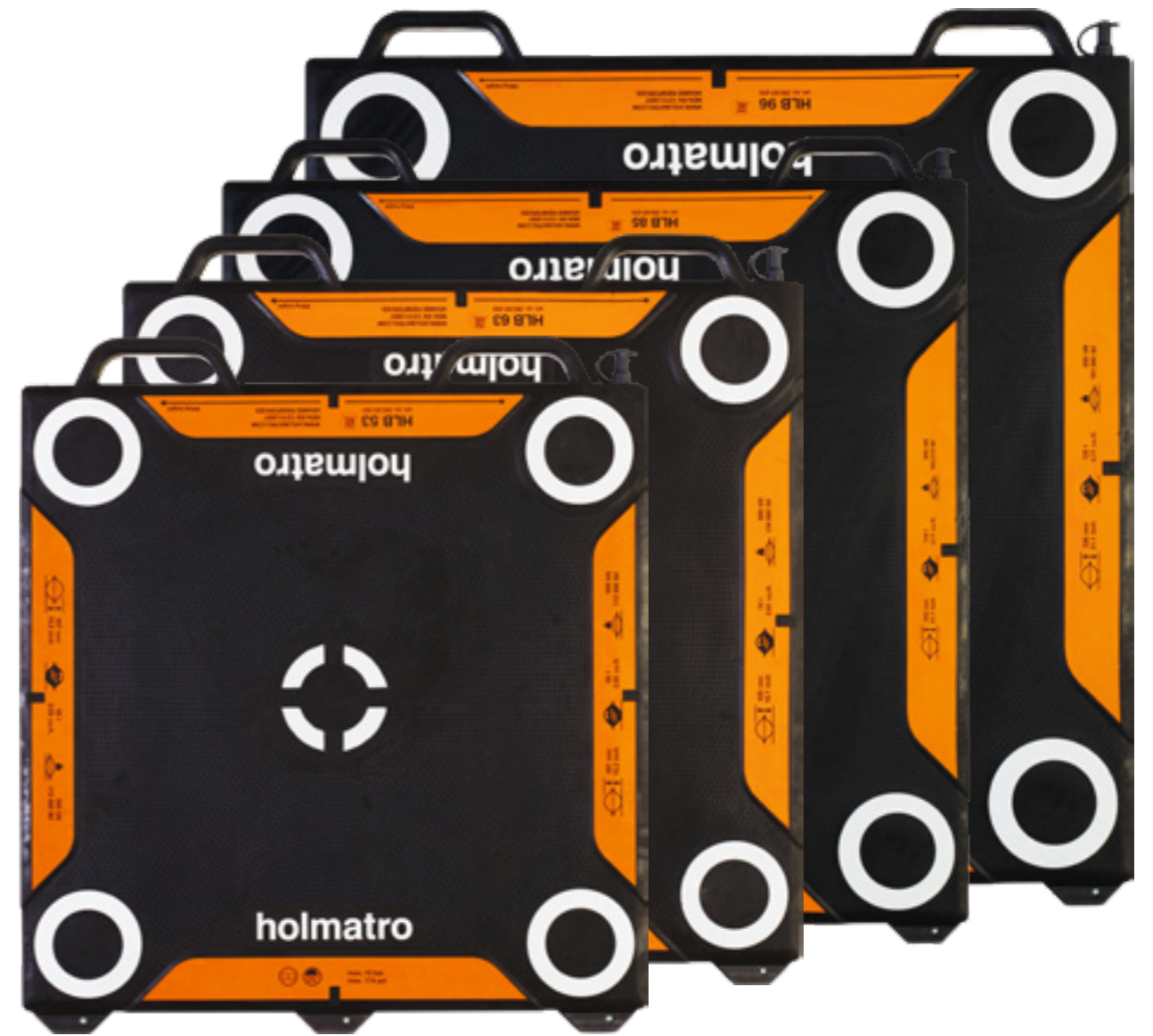

LARGE HLB 53 HLB 63 HLB 85 HLB 96

Two handles. Three slider pads.

HLB lifting bags - max. working pressure 12 bar					
model	art. no.	max. lifting capacity kN/t	max. inflation height mm	dimensions (L x W x H) mm	weight kg
HLB 53	350.321.031	520 / 53	411	767 x 690 x 27	15
HLB 63	350.321.032	620 / 63.2	456	827 x 750 x 27	17
HLB 85	350.321.034	855/87.2	550	948 x 870 x 27	23
HLB 96	350.321.033	940 / 95.9	565	987 x 910 x 27	25



HLB SYSTEM REQUIREMENTS

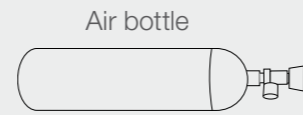

Pressure reducer

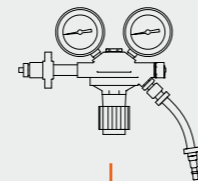

Control unit

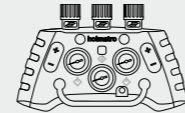

Shut-off hose

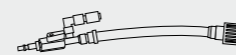

Lifting bag

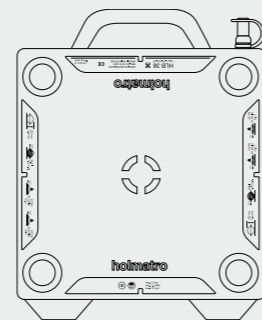

ADVISORY HLB SETS

How to select the right lifting bags with twelve models to choose from? Pick one of our set examples or ask for an advice based on your specific needs.

BASIC HLB LIFTING BAG SET

	quantity	art. no.
HLB 11	2	350.321.025
HLB 21	2	350.321.027
Air control set ACS 12	1	350.182.125
Air bottles 300 bar	2	350.581.096



ADVANCED HLB LIFTING BAG SET

	quantity	art. no.
HLB 16	2	350.321.026
HLB 31	2	350.321.028
HLB 53	2	350.321.031
Air control set ACS 12	2	350.182.125
Air bottles 300 bar	3	350.581.096



HEAVY HLB LIFTING BAG SET

	quantity	art. no.
HLB 21	2	350.321.027
HLB 38	2	350.321.030
HLB 63	2	350.321.032
HLB 96	2	350.321.033
Air control set ACS 12	2	350.182.125
Air bottles 300 bar	4	350.581.096



HSB SERIES



GREAT LIFTING HEIGHT AND OPTIMUM STABILITY

When inflating the new 12 bar Holmatro Stack Bags the contact surface will stay flat. This allows you to easily stack up to three bags, for safe and stable lifting over a greater height. The compact HSB stack bags all have the same lifting height, so even in small spaces you can raise heavy loads up to 510 mm.

DESIGNED AROUND YOU

The new Holmatro Stack Bags offer multiple options: you can use a single bag or stack two or three for a greater lifting height. Using a smaller set of bags will still get you the same lifting distance. The inflated stack bag becomes a sturdy flat object with a greater contact surface, for optimum stability and less risk of load shifting. The system is easy to handle, so get your lifting operation first time right with the new HSB stack bags!

Integrated dust cap

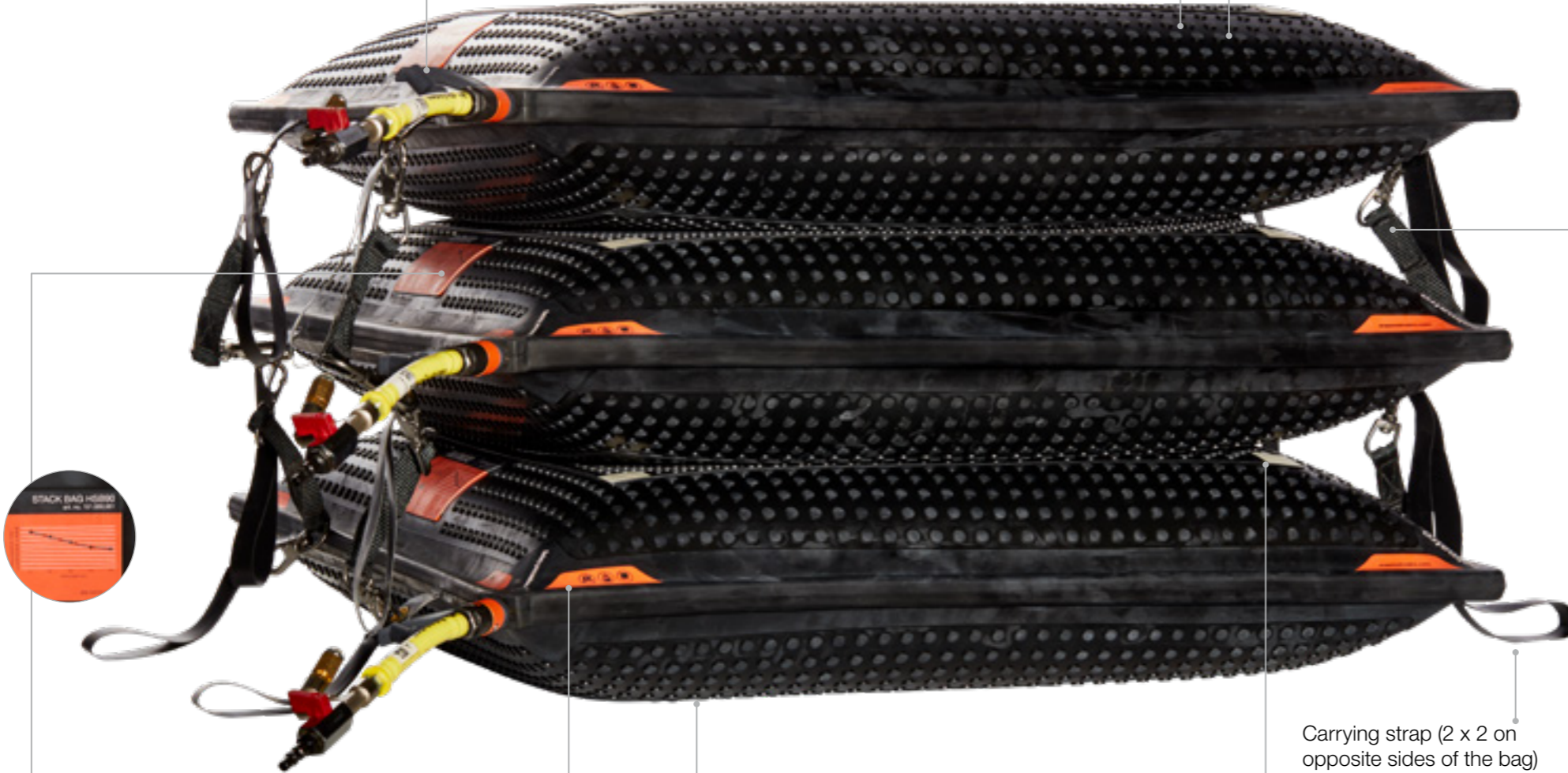

GRAPH OF LIFTING CAPACITY & LIFTING HEIGHT

Graph showing the maximum lifting capacity of a single stack bag at the start and when it is fully inflated.

IMPORTANT INFORMATION LABELS

Clear indication of safety warnings and technical specifications. Data matrix for equipment management in the free Holmatro Service Portal.

FLAT SURFACE

Contact surface remains flat when bag is pressurized. Stack up to three bags for stable, higher lifting. Maximum lifting height with three stacked bags is 510 mm, even with a set of the smallest bags.

CLEAR MARKINGS OF CONTACT AREA

For quick and easy stacking of up to three bags. The optimized non-slip profile maximizes the stability of inflated Stack Bags.

OPTIONAL RETAINING STRAPS

Easy carabiner style straps to help prevent stacked bags from shifting.

Aramid-reinforced, 4:1 safety

Optimized non-slip design

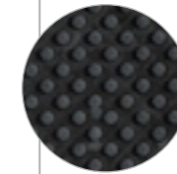

Control Unit HTC12



LED-illuminated Lightweight

AIR SOURCE PRESSURE GAUGE

Easy checking of incoming air pressure. Allows for timely air source replacement.

SAFETY COUPLER (ALSO ON HOSES)

Unlocks in two steps for improved safety: pressure release before hose disconnection.

CARRYING BAR

For easy carrying. Protects against damage and prevents accidental operation when the control is upside down.

INTUITIVE BUTTON OPERATION

Precise air flow regulation for controlled and safe lifting.

NON-RETURN VALVES

Independent controlled lifting: no risk of air pressure shifting from one bag to the other.

3 WAY CONTROLLER

Allows you to operate three Stack Bags with a single control unit. The HDC 12 (see page 7) is also compatible with the Stack Bags system, but can operate only two bags.

Full system compliant with all relevant safety standards, including EN 13731 and NFPA 1960.

WATCH THE VIDEO ON
HOLMATRO.COM/HSB

HSB STACK BAGS RANGE

Choose your Stack Bag: all models offer the same lifting height, so even with the smaller bags that occupy less ground space (small footprint) you will be able to reach a greater height when stacking three bags.



HSB27

HSB40

HSB74

HSB92

HSB Stack Bags - max. working pressure 12 bar

model	art. no.	max. lifting capacity kN/t	lifting capacity at max. lifting height kN/t	max. inflation height mm	dimensions (L x W x H) mm	weight kg
HSB27	151.000.948	265 / 27	84 / 8,6	170	520 x 520 x 27	9,2
HSB40	151.000.949	388 / 39,6	154 / 15,7	170	620 x 620 x 27	13
HSB74	151.000.950	724 / 73,8	370 / 37,7	170	840 x 840 x 27	23,8
HSB92	151.000.951	904 / 92,2	513 / 52,3	170	920 x 920 x 27	28



HSB SYSTEM REQUIREMENTS

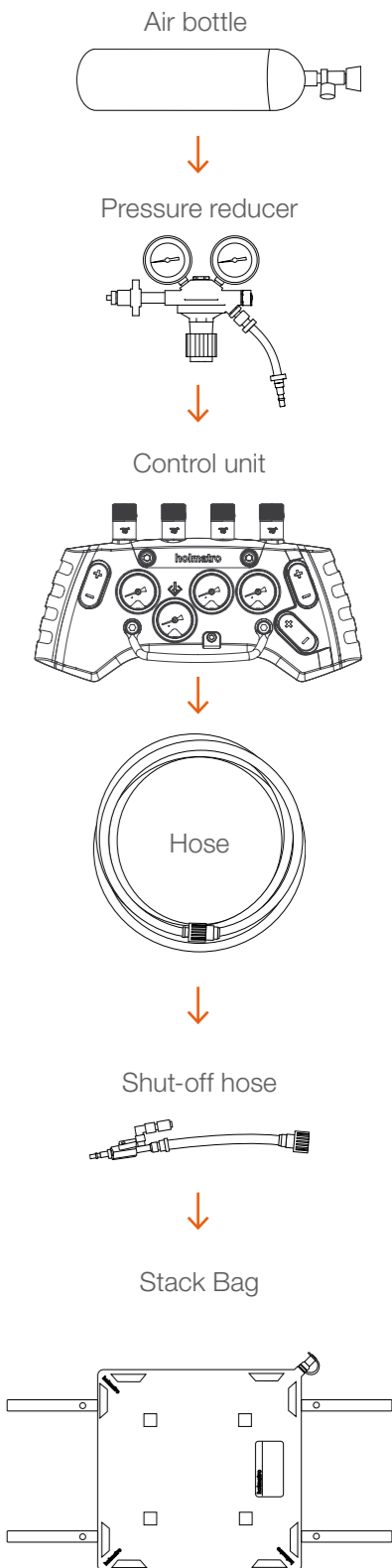

Accessories HLB and HSB see page 22.

ADVISORY HSB SETS

You will make the most of the benefits from the HSB series when stacking three bags. Pick your set: they will all reach the same lifting height but have different footprints and lifting forces.

SMALL HSB STACK BAG SET

	quantity	art. no.
HSB27	3	151.000.948
Air hose AH 5 Y	1	350.570.022
Air hose AH 5 B	1	350.570.023
Air hose AH 5 O	1	350.570.030
Control unit HTC12	1	151.002.137
Pressure reducer PRV 12	1	350.182.100
Shut-off hose SOH 12	3	350.182.096
Air bottle 300 bar	1	350.581.096
Air adapter set AAS 12	1	151.000.223
Retaining strap set	1	151.001.194

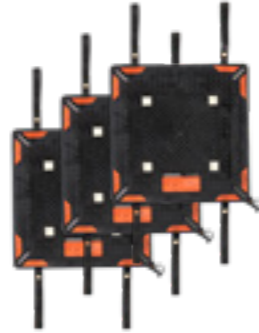

MEDIUM HSB STACK BAG SET

	quantity	art. no.
HSB40	3	151.000.949
Air hose AH 5 Y	1	350.570.022
Air hose AH 5 B	1	350.570.023
Air hose AH 5 O	1	350.570.030
Control unit HTC12	1	151.002.137
Pressure reducer PRV 12	1	350.182.100
Shut-off hose SOH 12	3	350.182.096
Air bottle 300 bar	1	350.581.096
Air adapter set AAS 12	1	151.000.223
Retaining strap set	1	151.001.194



LARGE HSB STACK BAG SET

	quantity	art. no.
HSB74	3	151.000.950
Air hose AH 5 Y	1	350.570.022
Air hose AH 5 B	1	350.570.023
Air hose AH 5 O	1	350.570.030
Control unit HTC12	1	151.002.137
Pressure reducer PRV 12	1	350.182.100
Connection piece	1	350.582.430
Shut-off hose SOH 12	3	350.182.096
Air bottle 300 bar	2	350.581.096
Air adapter set AAS 12	1	151.000.223
Retaining strap set	1	151.001.194

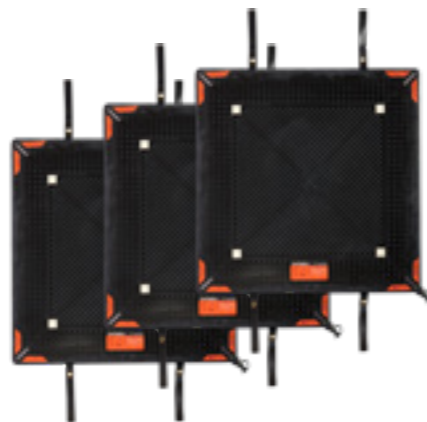

ADVISORY HSB SETS

EXTRA LARGE HSB STACK BAG SET

	quantity	art. no.
HSB92	3	151.000.951
Air hose AH 5 Y	1	350.570.022
Air hose AH 5 B	1	350.570.023
Air hose AH 5 O	1	350.570.030
Control unit HTC12	1	151.002.137
Pressure reducer PRV 12	1	350.182.100
Connection piece	1	350.582.430
Shut-off hose SOH 12	3	350.182.096
Air bottle 300 bar	2	350.581.096
Air adapter set AAS 12	1	151.000.223
Retaining strap set	1	151.001.194

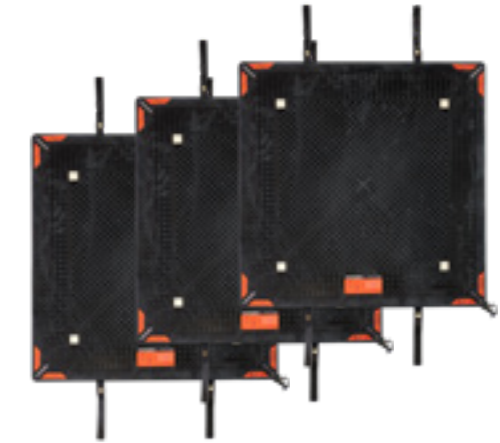

THE CHOICE IS YOURS

Lifting height

HLB LIFTING BAGS STACK 2 X HLB

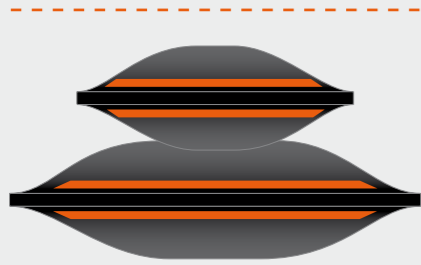

A maximum of two bags can be stacked, using a smaller bag on top of a larger one.

HSB STACK BAGS STACK 3 X HSB



Three bags can be stacked with great stability and increased height.

Footprint

HLB LIFTING BAGS 1 X HLB



Great lifting capacity and height of individual bags: use only a single bag. A large HLB lifting bag requires more ground space (footprint).

HSB STACK BAGS 3 X HSB

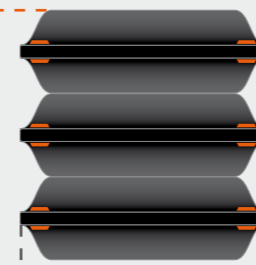

Stack Bags occupy less ground space: they have a smaller footprint with a greater lifting height when stacked.

Stability

HLB LIFTING BAGS BALLOON SHAPE

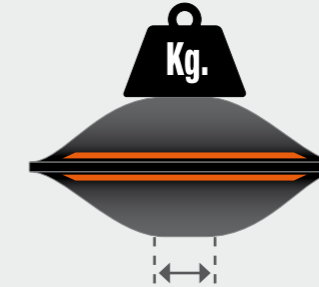

Smaller contact area as the bag inflates.

HSB STACK BAGS FLAT SHAPE

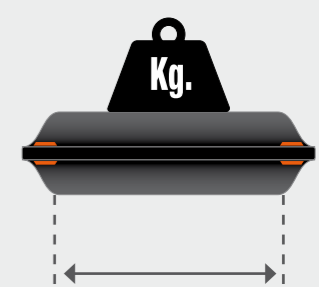

Greater contact surface and stability.

CAPACITY VERSUS HEIGHT

HLB LIFTING BAGS POWER CURVE DROPS TO NEAR 0

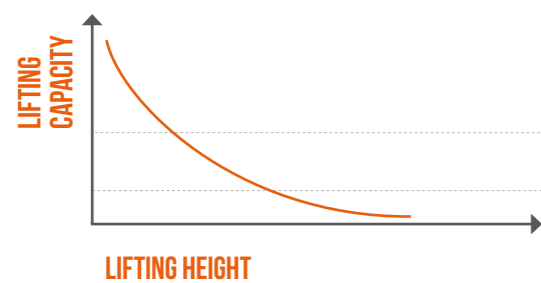

Large initial lifting capacity, drops to near zero at maximum lifting height. Because of the ballooning effect the lifting capacity diminishes when the bag is inflated.

HSB STACK BAGS DROP IN POWER CURVE STOPS

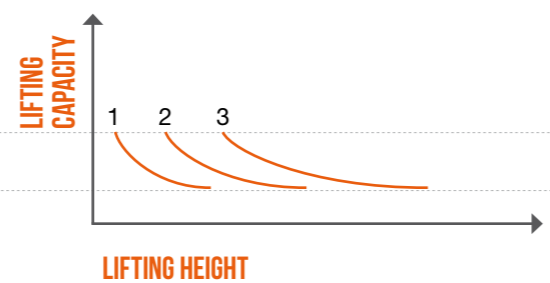

Smaller initial lifting capacity, drop in lifting capacity stops when bag reaches maximum height (170 mm for one bag, 510 mm for three stacked bags).

The HLB lifting bags and the HSB Stack Bags have been designed to lift heavy objects in vehicle rescue and disaster response situations. Check out which system suits your needs best!

**HLB LIFTING BAGS
ALLROUND LIFTING BAGS**

**HSB STACK BAGS
STABLE STACKING AT
GREATER HEIGHT**

ACCESSORIES HLB & HSB

air hoses					
item	description	length	art. no.	HLB	HSB
1	Air hose AH 5 Y	5 m	350.570.022	✓	✓
2	Air hose AH 5 B	5 m	350.570.023	✓	✓
3	Air hose AH 5 O	5 m	350.570.030	✓	✓
4	Air hose AH 10 Y	10 m	350.570.027	✓	✓
5	Air hose AH 10 B	10 m	350.570.026	✓	✓
6	Air hose AH 10 O	10 m	350.570.031	✓	✓

accessories					
item	description	art. no.	HLB	HSB	
7	Control unit HDC 12	350.182.095	✓	✓	
8	Control unit HTC12	151.002.137	✓	✓	
9	Pressure reducer PRV 12	350.182.100	✓	✓	
10	Connection piece	350.582.430	✓	✓	
11	Air control set ACS 12	350.182.125	✓	✓	
12	Shut-off hose SOH 12	350.182.096	✓	✓	
13	Air bottle 300 bar	350.581.096	✓	✓	
14	Lifting eyes set (2 pieces) **	350.182.129	✓	--	
15	Air adapter set AAS 12	151.000.223	✓	✓	
16	Slider pads set (3 pieces) *	151.000.180	✓	--	
17	Retaining strap set (4 pieces)	151.001.194	--	✓	

* Standard for models HLB 11 and up | ** Optional for models HLB 31 and up



HOLMATRO OFFICES AND DEALERS

All over the world

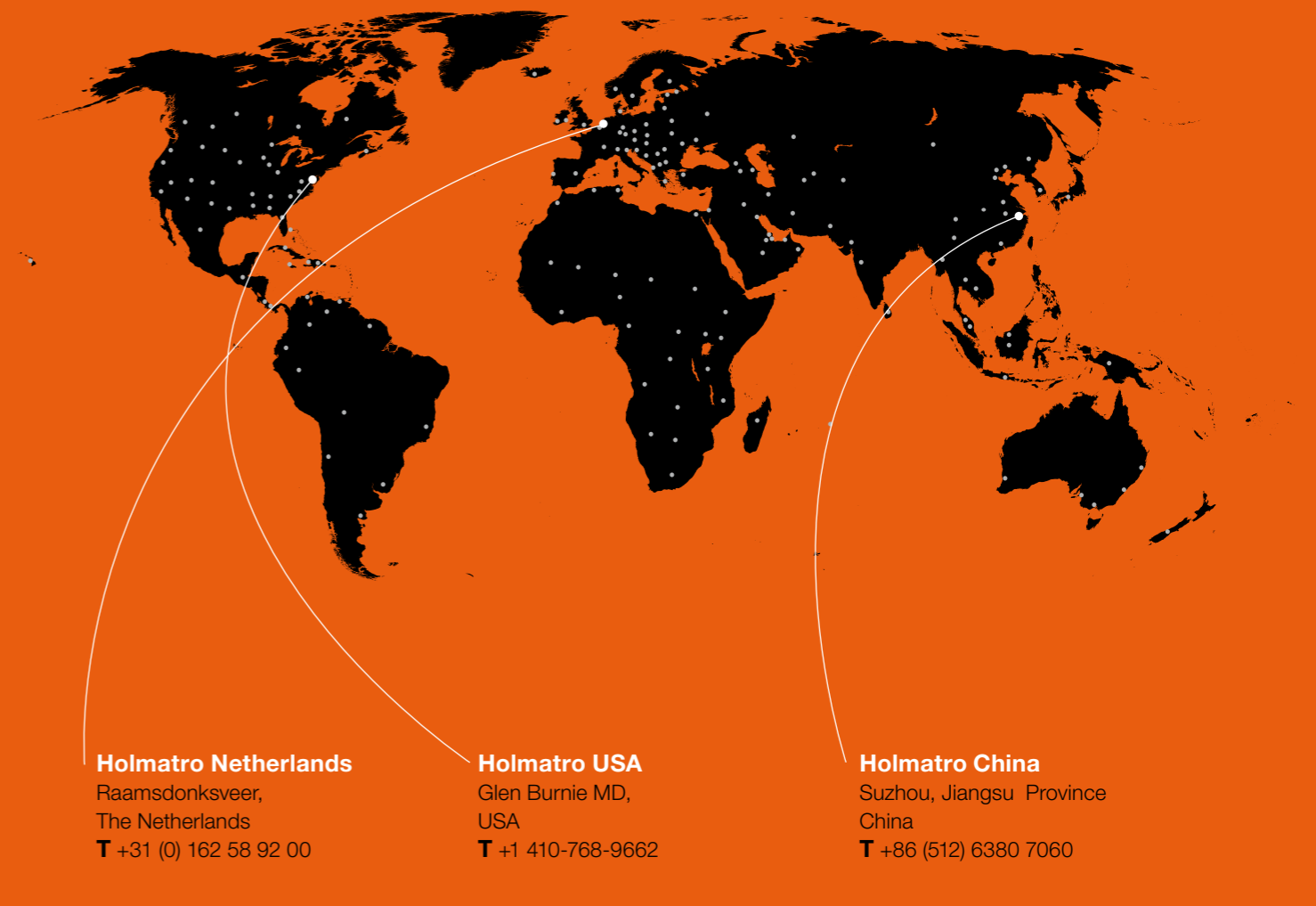

Thanks to our worldwide sales and service network there's always a Holmatro representative nearby, ready to assist you!

Find your nearest Holmatro representative on holmatro.com

Disclaimer - While the greatest care has been devoted to the content, it is possible that the information in this document is incorrect or incomplete. Holmatro B.V. and its affiliated companies (here-after: Holmatro) cannot be held liable in any way for the consequences of activities undertaken based on this document. If you have any doubts about the correctness or completeness of the information, you shall contact Holmatro (phone number: +31 (0)162-589200). Nothing from this document can be copied and/or made public in any way without the explicit authorization of Holmatro.

**YOU CAN COUNT ON US,
FOR LIFE**

holmatro.com

 Holmatro Rescue World

 @HolmatroRescue

 holmatrorescue

 HolmatroRescue

 Holmatro Rescue Equipment

 @holmatrorescue